

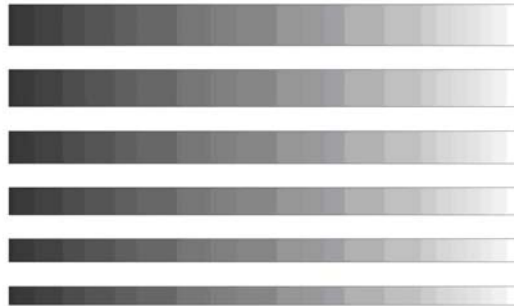

RANGE HOOD OPERATING INSTRUCTIONS



Before using this range hood,
please read these instructions
completely.



READ AND SAVE THIS INSTRUCTIONS

FOR DOMESTIC COOKING ONLY

Installer: Leave this manual with the homeowner.

**Homeowner: Cleaning, Maintenance and Operating
instructions on the coming pages.**

**RANGE HOOD ITEM NO.: K1022/K1022A
REFERED MODEL NO.: 3502C1**



**MOTOR WITH UL CERTIFICATE
NUMBER: E312110**

READ AND SAVE THESE INSTRUCTIONS

⚠ INTENDED FOR DOMESTIC COOKING ONLY ⚠

⚠⚠ WARNING

TO REDUCE THE RISK OF FIRE, ELECTRIC SHOCK, OR INJURY TO PERSONS, OBSERVE THE FOLLOWING:

1. Use this unit only in the manner intended by the manufacturer. If you have questions, contact the manufacturer at the address or telephone number listed in the warranty.
2. Before servicing or cleaning unit, switch power off at service panel and lock service panel to prevent power from being switched on accidentally. When the service disconnecting means cannot be locked, securely fasten a prominent warning device, such as a tag, to the service panel.
3. Installation work and electrical wiring must be done by a qualified person(s) in accordance with all applicable codes and standards, including fire-rated construction codes and standards.
4. Sufficient air is needed for proper combustion and exhausting of gases through the flue (chimney) of fuel burning equipment to prevent backdrafting. Follow the heating equipment manufacturer's guidelines and safety standards such as those published by the National Fire Protection Association (NFPA), and the American Society for Heating, Refrigeration and Air Conditioning Engineers (ASHRAE), and the local code authorities.
5. When cutting or drilling into wall or ceiling, do not damage electrical wiring and other hidden utilities.
6. Ducted fans must always be vented to the outdoors.
7. Do not use this unit with any separate solid-state speed control device.
8. To reduce the risk of fire, use only metal ductwork.
9. This unit must be grounded.

TO REDUCE THE RISK OF A RANGE TOP GREASE FIRE:

- A. Never leave surface units unattended at high settings. Boil over cause smoking and greasy spillovers that may ignite. Heat oils slowly on low or medium settings.
- B. Always turn hood ON when cooking at high heat or when flam being food (i.e. Crepes Suzette, Cherries Jubilee, Peppercorn Beef Flam be').
- C. Clean ventilating fans frequently. Grease should not be allowed to accumulate on fan or filter.
- D. Use proper pan size. Always use cookware appropriate for the size of the surface element.

⚠⚠ WARNING

TO REDUCE THE RISK OF INJURY TO PERSONS IN THE EVENT OF A RANGE TOP GREASE FIRE, OBSERVE THE FOLLOWING:*

1. SMOTHER FLAMES with a close-fitting lid, cookie sheet, or metal tray, then turn off the burner. BE CAREFUL TO PREVENT BURNS. If the flames do not go out immediately, EVACUATE AND CALL THE FIRE DEPARTMENT.
2. NEVER PICK UP A FLAMING PAN - You may be burned.
3. DO NOT USE WATER, including wet dishcloths or towels - violent steam explosion will result.
4. Use an extinguisher ONLY if:
 - A. You know you have a Class ABC extinguisher and you already know how to operate it.
 - B. The fire is small and contained in the area where it started.
 - C. The fire department is being called.
 - D. You can fight the fire with your back to an exit.

* Based on "Kitchen Fire Safety Tips" published by NFPA.

⚠ CAUTION

1. To reduce risk of fire and to properly exhaust air, be sure to duct air outside. Do not vent exhaust air into spaces within walls or ceilings or into attics, crawl spaces, or garages.
2. Take care when using cleaning agents or detergents.
3. Avoid using food products that produce flames under the Range Hood.
4. For general ventilating use only. Do not use to exhaust hazardous or explosive materials and vapors.
5. To avoid motor bearing damage and noisy and/or unbalanced impellers, keep drywall spray, construction dust, etc. off power unit.
6. Your hood motor has a thermal overload which will automatically shut off the motor if it becomes overheated. The motor will restart when it cools down. If the motor continues to shut off and restart, have the hood serviced.
7. For best capture of cooking impurities, the bottom of the hood should be a minimum of 24" and a maximum of 33" above the cooking surface.
8. Two installers are recommended because of the large size and weight of this hood.
9. This product is equipped with a thermostat which may start blower automatically. To reduce the risk of injury and to prevent power from being switched on accidentally, switch power off at service panel and lock or tag service panel.
10. Use with approved cord-connection kit only.
11. Please read specification label on product for further information and requirements.

PREPARE THE HOOD

Unpack hood and check contents.

You should receive:

1 - Hood

1 - Decorative Flue Assembly

1 - Parts Bag containing:

1 - Mounting Bracket

1 - Vent

1 - Duct fixing support

1 - Slidery duct fixing support

7 - Mounting Screws (4 x 50mm)

8 - Mounting Screws (4 x 8mm)

4 - Mounting Screws (4 x 25mm for glass installation)

4 - Glass washer (for glass installation)

4 - Rubber washer (for glass installation)

9 - Drywall Anchors (ϕ 8 holes)

1 - Aluminum Flex Duct

1 - Installation Instructions

1 - Warranty Card

2- Safety screw (ST4mm x30mm)

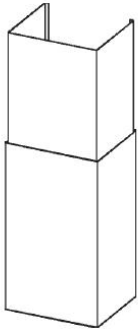

DECORATIVE
FLUE

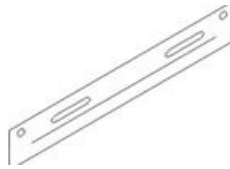

DUCT FIXING SUPPORT

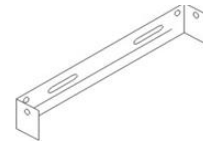

SLIDERY DUCT FIXING SUPPORT



MOUNTING
SCREWS (4
X 8MM)

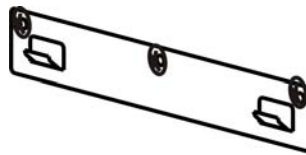

MOUNTING BRACKET



DRYWALL
ANCHORS



MOUNTING
SCREWS (4 X
50MM)



SAFETY SCREW (ST4MM x30MM)



VENT



MOUNTING
SCREWS
(4 X 25MM)

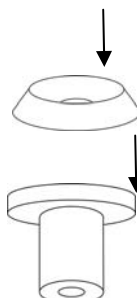

GLASS
WASHER

RUBBER
WASHER



ALUMINUM FLEX
DUCT

WARNING

Note: This range hood must be properly grounded. The unit should be installed by a qualified electrician in accordance with all applicable national and local electrical codes.

The minimum hood distance above cooktop must not be less than 24". A maximum of 33" above cooktop is highly recommended for best capture of cooking impurities. Distances over 33" are at the installer and users discretion.

INSTALL THE DUCTWORK

NOTE: To reduce the risk of fire, use only metal ductwork.

1. Decide where the ductwork will run between the hood and the outside.
2. A straight, short duct run will allow the hood to perform most efficiently.
3. Install the Aluminum Flex duct on the vent towards hood location.

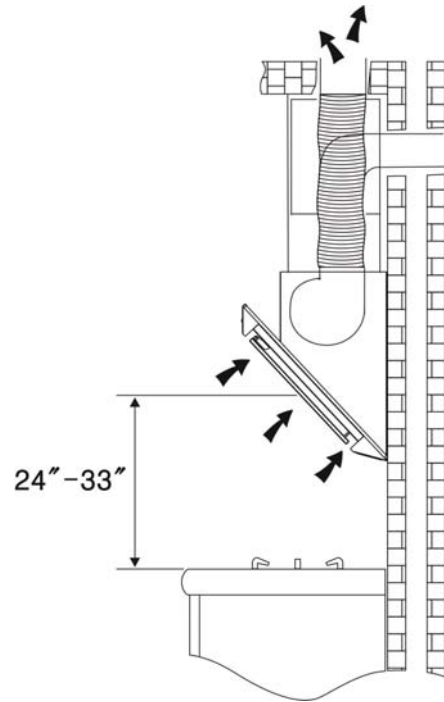

INSTALL MOUNTING BRACKETS

1. After evaluating the height of the hood, place the hook center over installation location. Drill 3 holes of $\text{\O}8\text{mm}$ on a suitable place to fix the mounting brackets.
2. Put the drywall anchors into the holes and fix the mounting screws (4x50mm) into the anchors, and install the hook on the wall as shown.

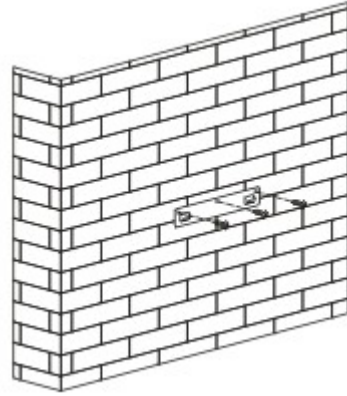

INSTALL SLIDERY DUCT FIXING SUPPORT

1. Calculate the final height of the U-shaped section, drill 2 holes of $\text{\O}8\text{mm}$ on a suitable place in line with the slidery duct fixing support.
2. Put the drywall anchors into the holes and fix the mounting screws (4x50mm) into the anchors, and install the hook on the wall as shown. (The rest two pares of 4x50mm screw and drywall anchors are for spare)

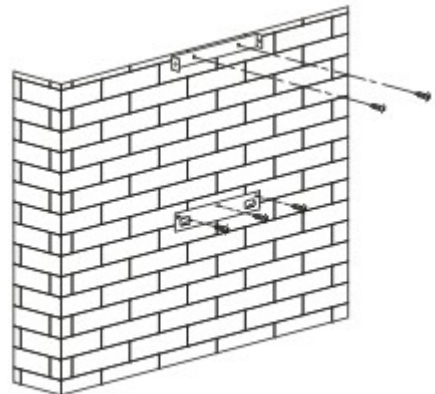

NONE-DUCTED RECIRCULATION FILTER INSTALLATION

1. Purchase a non-ducted recirculation filter from your dealer.
2. Install the filter by rotating it onto the equipment which stands on two sides of the motor.

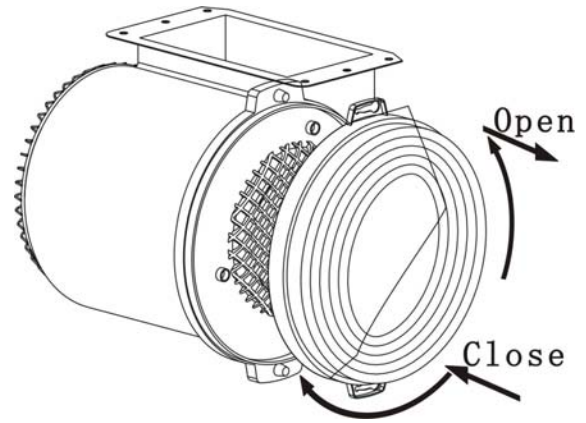

PREPARE THE HOOD

Note: On stainless steel hoods, carefully remove the plastic protective film from all exterior surfaces of the hood and decorative flues, prior to final installation.

3. Pick out the hood from the carton.
4. Install the vent into the duct connector of the cooker hood.
5. Fix the extensive pipe onto the vent.

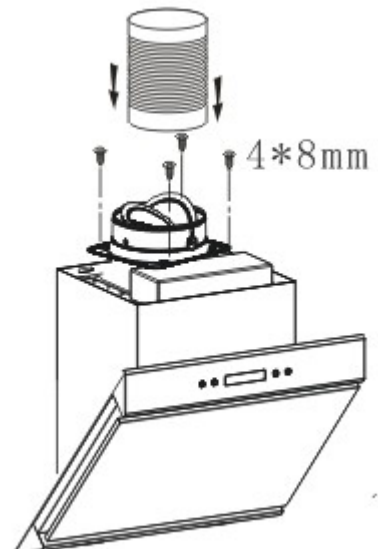

INSTALL THE HOOD

Note: at least two people will be required to mount the hood.

1. Raise the hood into its mounting position.
2. Align the rectangular opening on the back of the hood with the wall-mounting bracket. Gently lower the hood until it securely engages the bracket.
3. Open the Baffle filter and find the two $\phi 6$ mm holes on the back of the hood. Level the hood with 2 mounting screws (4*30mm). Use drywall anchors provided.

4. Put the glass in the lead way, use four screws (4x25mm) with glass washer and rubber washer to fix the glass. (Note: the screws and washers should be install as shown.)

5. Measure the height of the glass to the sliding duct fixing support. Adjust the height of the chimney according to the height. Then use the duct fixing support with two screws (4x8mm) to fix the chimneys. Shown as in the pic.

6. Put the chimney on the hood, use two screws (4x8mm) to fix the chimney to the sliding duct fixing support.

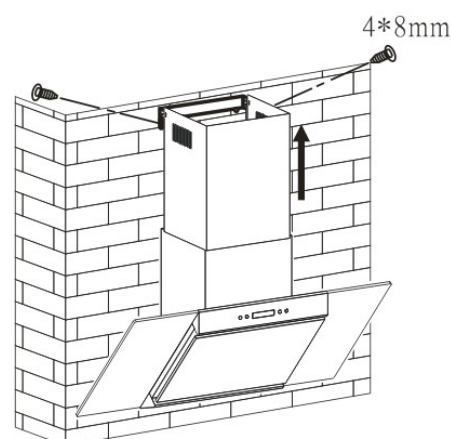
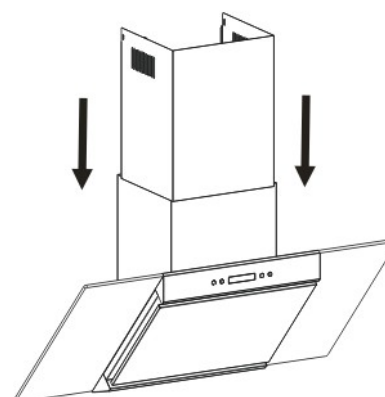
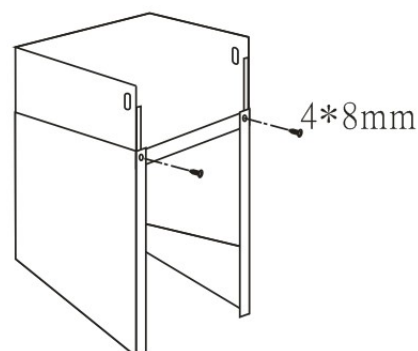
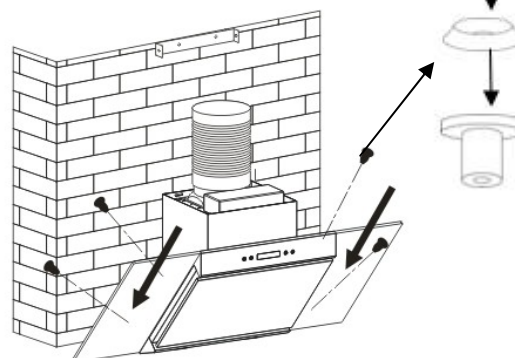
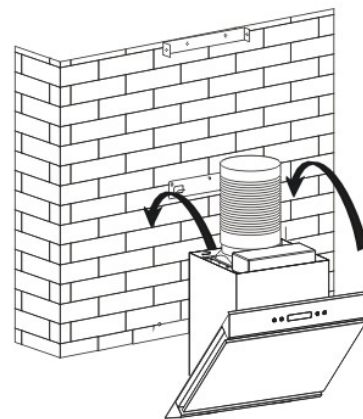

MAINTENANCE

Proper maintenance of the Range Hood will assure proper performance of the unit.

Filters

The filters must be cleaned approximately once every 30 hours of operation (when the central segment on the display goes on or starts blinking).

Use a warm detergent solution. Filters are dishwasher safe.

Remove filter by pushing filter towards the back of hood and rotating filter downward.

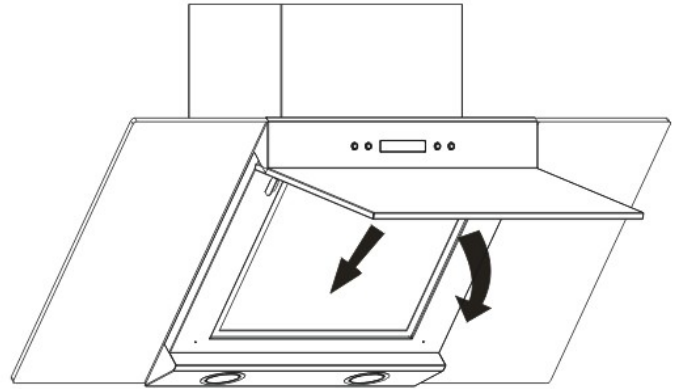

Duct free(Carbon) Filters

The duct free filters should be changed every 6 months. Rotate the filters to remove and replace.

Hood Cleaning

Stainless steel is one of the easiest materials to keep clean. Occasional care will help preserve its fine appearance.

Cleaning tips:

- Hot water with soap or detergent is all that is usually needed.
- Follow all cleaning by rinsing with clear water. Wipe dry with a clean, soft cloth to avoid water marks.
- For discolorations or deposits that persist, use a non-scratching household cleanser or stainless steel polishing powder with a little water and a soft cloth.
- For stubborn cases, use a plastic scouring pad or soft bristle brush together with cleanser and water. Rub lightly in direction of polishing lines or "grain" of the stainless finish. Avoid using too much pressure which may mar the surface.
- DO NOT allow deposits to remain for long periods of time.
- DO NOT use ordinary steel wool or steel brushes. Small bits of steel may adhere to the surface causing rust.
- DO NOT allow salt solutions, disinfectants, bleaches, or cleaning compounds to remain in contact with stainless steel for extended periods. Many of these compounds contain chemicals which may be harmful. Rinse with water after exposure and wipe dry with a clean cloth.

Painted surfaces should be cleaned with warm water and mild detergent only.

OPERATION



Controls

Always turn the hood ON before cooking in order to establish an air flow in the kitchen. After turning off the range, let the hood run for a few minutes to clear the air.

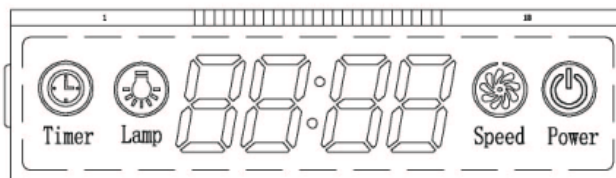

● LCD switch







1. Power on: Switch on the power supply, and the backlight is lit, displaying "24-hour system". The output is then blocked up, and the machine enters standby status. The backlight disappear automatically 30 seconds later under the condition of none operation.

2. Press "Lamp" key: Press the indicator key once, the indicator  on the LCD screen is lit and lights on. Press it for a second time, indicator  on the LCD screen distinguished and the lights off. The Lamps work independently, not controlled by Timer and Power.





3. Power on key , the motor is provided with three speeds, i.e. low, medium and high.

1) Press key ,  is displayed on the display screen, and the motor start working on low speed, key  also lit.

2) Press  key when the motor is working on the low speed, motor transfers to medium speed.  keep lit and work.



3) Press  key when the motor is working on medium speed, and motor transfers to high speed,  key keep lit and work.





4) It could be chose "low speed-medium speed-high speed-low speed-medium speed....."by  key under working position..

4. Press key , the motor is adjusted. Press key  again, the motor stop. Key  and 





5. Timer key : it has been set on 12:00, when power off, it also show 12:00. Customer need to set the time again.

1) When lamp button and speed button don't work, the timer key is used for time setting.

A) Long press timer key  for 2-5 seconds, time segment , and the first two hour bit segment

flash, use key  for the digit increase, use  key for the digit decrease. Namely: The variable is 01 each time when it is pressed; the hour segment is with the largest digit of 23. If it exceeds 23,  key is null and void. If it is equal to 00, then the  key is null and void.

B) Press the timer key  for the 2nd time, time segment , and the last two minute bit segment

flash, se key  for the digit increase, use  key for the digit decrease. Namely: The variable is 01 each time it is pressed; the hour segment is with the largest digit of 59. If it exceeds 59,  key is null and void. If it is equal to 00, then the  key is null and void.

C) Press the timer key  for the 3rd time, and it is the time setting confirm and exit.

D) Long press timer key  for 2-3 seconds under this operation mode, and it is for the hour setting; Press it for the 2nd time: Setting for the minute; Press it for the 3rd time: For the time setting exit and confirm, and it will be repeated again and again (if the 1st time pressing doesn't exceed 2 seconds, then it can't run this operating procedure.)

2) The timer key is the timer setting key when the motor is working. If only press Lamp key, the timer key

is null and void.

A) Press timer key, enter the setting display. 1st time setting is 5 min. Use speed key for increase gradually, use lamp key for decrease gradually, the time should be set 1:00—60:00 min. Finish setting, press timer key to confirm.

B) Example: Let the setting time be 5min, the display is 5:00, 4:59, ...00:1, with 0:00 displays per minute, and once "00: 00" appears, the motor position and the indicator power supply will be cut off automatically, (the display screen displays "24-hour system", the output is blocked up, and the soot machine enters standby status, and the backlight will be put out automatically 30 seconds later.)

When use time setting next time, press timer key and not change timer setting, the soot machine will keep the time automatically . 5 min later, it starts to decrease gradually. If reset the time, it will work for new time.

HALOGEN BULBS

ALWAYS SWITCH OFF THE ELECTRICITY SUPPLY BEFORE CARRYING OUT ANY OPERATIONS ON THE APPLIANCE.

To change bulbs:

1. Use a screwdriver to pull out the lampshade and get off the glass. CAUTION: BULB MAY BE HOT, PLEASE ROTATE WHEN THE BULB IS COOL!
2. Replace with a Type JC, 12Volt, 20Watt Max, G-4 Base bulb. Do not touch replacement bulb with bare hands! If the bulb is touched with the bare hand, it should be cleaned with a lint-free cloth moistened with methylated spirit.
3. Fix the glass and lampshade back the light after replacing the bulb.

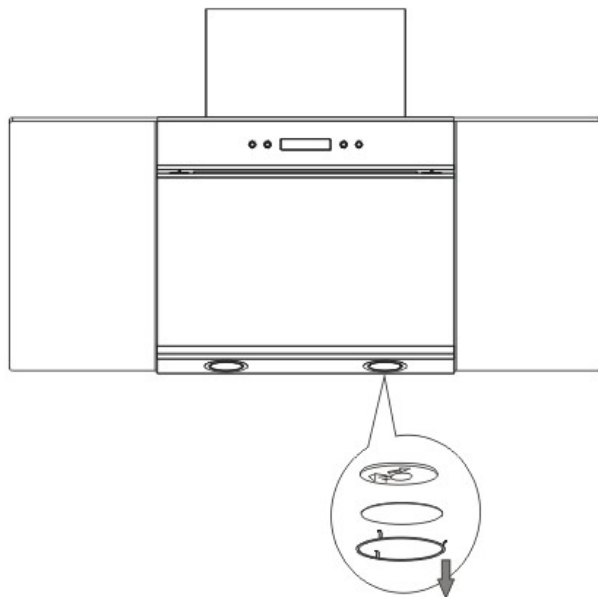

LED LIGHTS

ALWAYS SWITCH OFF THE ELECTRICITY SUPPLY BEFORE CARRYING OUT ANY OPERATIONS ON THE APPLIANCE.

To change the light:

Open the filter and find the spring of the light, push the spring and the light will be slip out. Change the light as with same kind of 4Volt, 3 Watt LED light. CAUTION: LIGHT MAY BE HOT, PLEASE ROTATE WHEN THE LIGHT IS COOL!

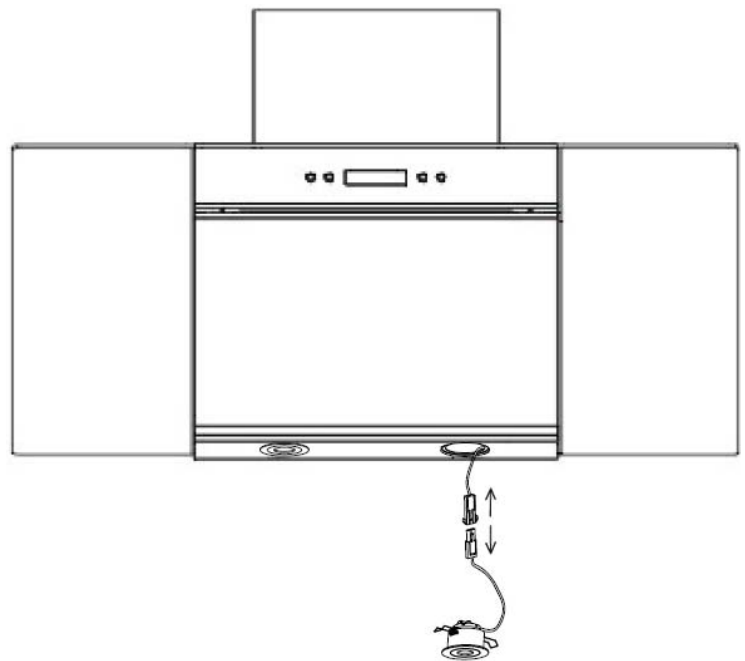

WARRANTY

We will warrant this product free from defects in material and quality for one year and motor for 5 years. If any problems occur from correct usage, please contact the service department for under warranty service.

This warranty does not cover the following:

The filter mesh and bulb.

Commercial use.

Amendment of the date of manufacture on the rating plate.

Damaged caused to the body by usage of detergent sprayer.

Pollution made to the led parts, glass parts and S/S parts.

Incorrect installation, misuse, abuse or neglect.

Incorrectly fitted to insufficient or unsuitable power.

Taken apart or serviced by unauthorized service engineers or replaced with other manufacture's components.

For commercial use the maintenance and free service should be discussed with our authorized agent.

Beyond the 12 month limited warranty period, the purchaser should pay for charge of components and call out.

In the event of a service call, please provide the warranty card and receipt of date of purchase.

K-Star International Group Inc.
K-Star Electronic Appliance Inc.

Toll Free:(800) 893-2168

Email:info@kstarus.com

<http://www.kstarus.com>